

Mani 100 - LED Slimline Mirror

CODE: MLMIMA100

SIZE: H 950 x W 1000 x D 30mm

NET WEIGHT: 11.4 Kg

FEATURES:

- LED Slimline Mirror
- Multi Functional Contactless Sensor Controls Light from Cool - Warm Brightness with Memory Function
- Phantom Lighting
- Landscape or Portrait
- Heated Demister Pad
- IP44 Rating

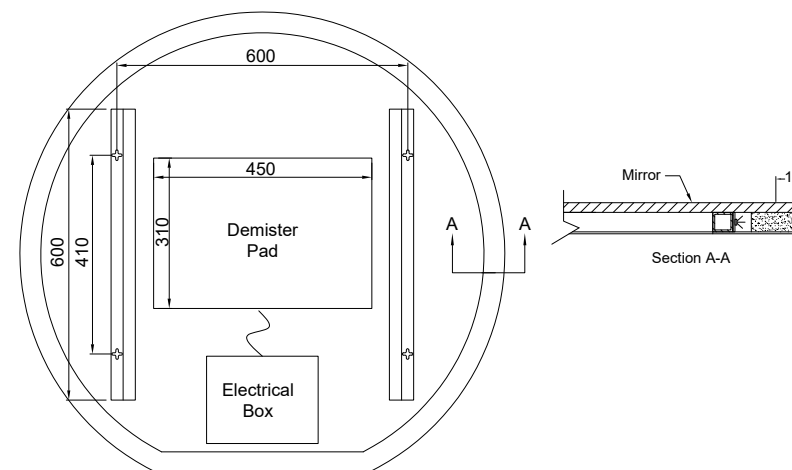
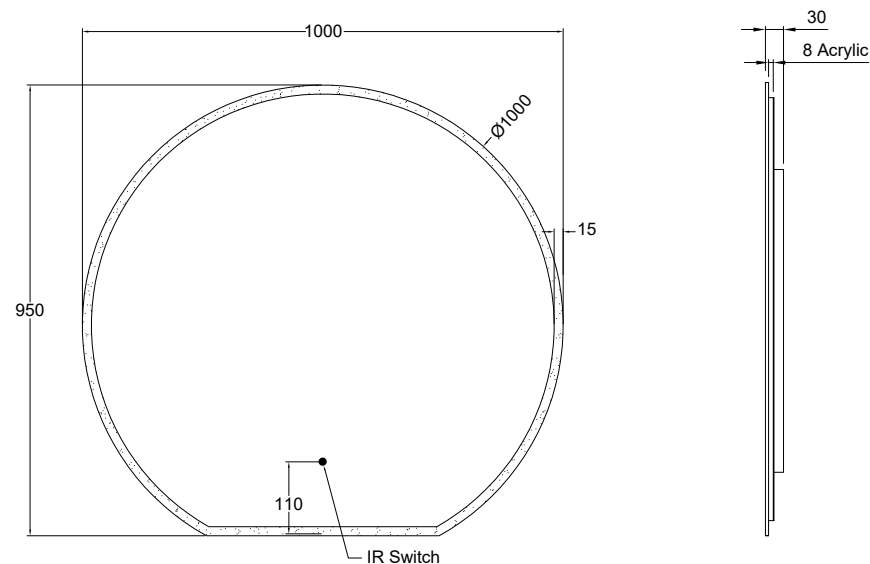

The information contained on this page was correct at date of issue. Fitting dimensions are provided as a guide only. Some variation may occur due to manufacturing tolerances. We pursue a policy of continuing improvement in design and performance of our products and so reserve the right to change specifications without prior notice.